

MEDIUM SHAKER (NB-101M/NB-101MT/NB-101MC)

Magnetic Induction Drive & Brush Less DC Motor provide ideal shaking function for cell culture, sample mixtures, suspension, micro biology, chemistry. Enjoy its stable shaking and quite operation along with small foot print.



STACKABLE SHAKERS
NB-M4S

NB-101MC

NB-101MT

NB-101M

NB-101M RC

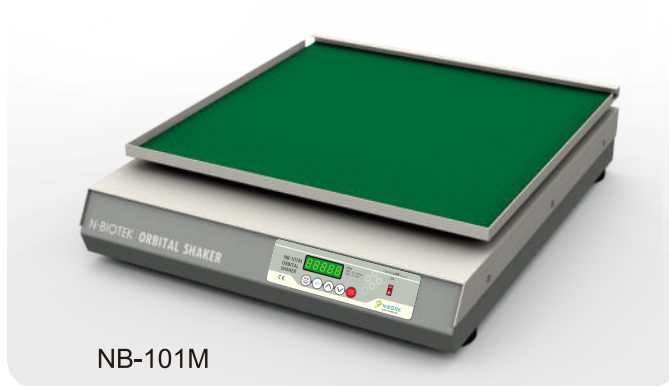

MEDIUM SHAKER

Medium Shakers are used for the experiment of the pathology clinics, cells/microbes cultivation and extractions, planet tissue section mounting.



Shaking Type



MULTI SHAKER

Multi-shaker provides dual function choosing either orbital motion or reciprocating motion which is used in Mixing reagent, physical clinic, shaking culture, cell culture.



Shaking Type

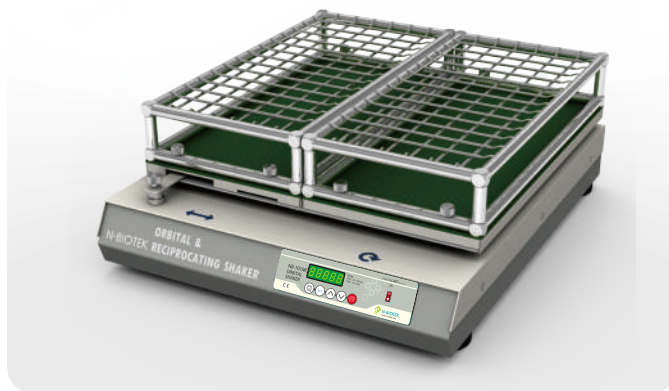

COMBINATION SHAKER

Using two separate platforms, both orbital and reciprocating shaking motion are available in one shaker. Also, both platforms can be combined like one platform and run in orbital motion.

Using two separate platforms, both orbital and reciprocating shaking motion are available in one shaker. Also, both platforms can be combined like one platform and run in orbital motion.

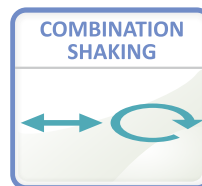

Shaking Type

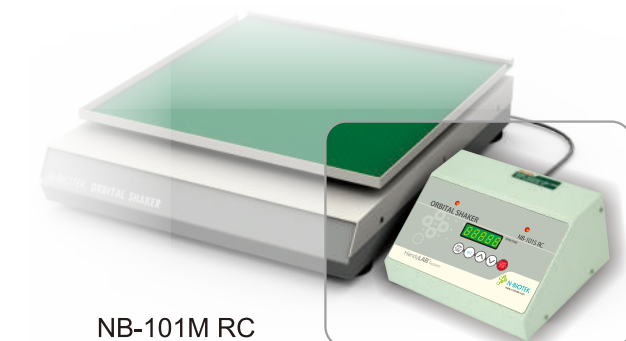

SHAKER REMOTE CONTROLLER

Ane into Incubator Shaker used to facilitate the adjustment controls were isolated from the outside.

*Applicable to all of shakers.

SHAKERS

Special Features



Plate type Brushless DC MOTOR provides Low Vibration, Low Dust & Low Noise.

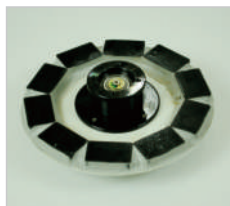

Magnetic Induction Drive.

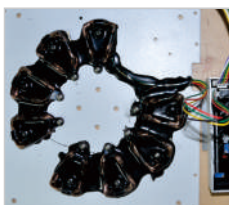

Epoxy coated coil plate for Moisture-Proof.



Selection Lever for NB-101MC

Features

- Plate Type Brushless DC motor provides low noise, low vibration and maintenance free system.
- Artificial intelligence system which maintains precise speed and adjust time controlled by MICOM.
- LED indicates temperature, speed, time and state of power failure.
- Possible to operate up to 400rpm despite large, stroke 30mm
- Possible to operate in Cold Chamber and Incubators (4℃~60℃)
- Easy to change accessory platform.

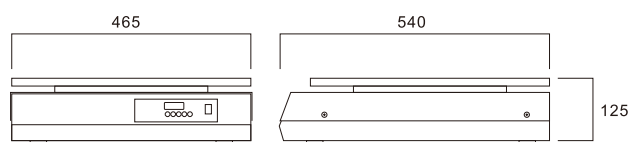

NB-101M

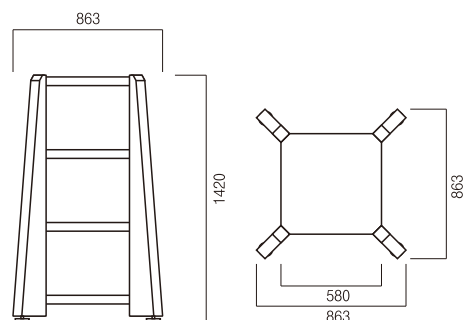

NB-M4S

*Height can be changed by accessories.

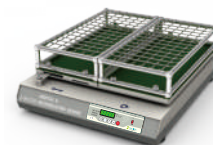
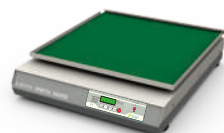

Specification

Items	Unit	NB-101M	NB-101MT	NB-101MC
Motion		Orbital	Orbital or Reciprocating	Orbital & Reciprocating
Speed				
range	rpm	30 to 300 rpm (up to 400rpm:high speed type)	30 to 300 rpm	30 to 300 rpm
accuracy	rpm	±1rpm	±1rpm	±1rpm
increment	rpm	1 rpm	1 rpm	1 rpm
Time				
range	min	Continuous or up to 47h 59min	Continuous or up to 47h 59min	Continuous or up to 47h 59min
accuracy	%	±1%	±1%	±1%
increment	min	1 minute	1 minute	1 minute
Control		Microprocessor Digital	Microprocessor Digital	Microprocessor Digital
Motion control		–	Lever Operate	Lever Operate
Operating panel		Touch Button	Touch Button	Touch Button
Display		LED Display	LED Display	LED Display
Motor		Plate Type BL/DC Motor	Plate Type BL/DC Motor	Plate Type BL/DC Motor
Drive system		Beltless Direct Drive	Beltless Direct Drive	Beltless Direct Drive
Orbit Diameter	mm	30mm	30mm	30mm
Platform size	mm,ea	460(W)x455(D)mm with Rubber Pad	460(W)x455(D)mm with Rubber Pad	220(W)x455(D)mmx2
Dimensions	mm	465(W)x540(D)x125(H)mm	465(W)x540(D)x145(H)mm	465(W)x540(D)x195(H)mm
Holder/Rack		Rubber Pad	Rubber Pad	Spring Rack
Weight	kg	29kg	35kg	38kg
Power	V/Hz	110/220V, 50/60Hz, 20W	110/220V, 50/60Hz, 30W	110/220V, 50/60Hz, 30W

Accessories

Detail about accessories are written at the end of the section.



Platform
(Tube Rack & Holder)

NB-101M
NB-101MT

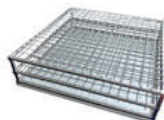

Spring rack

NB-101M
NB-101MT



250ml x 23ea

NB-101M
NB-101MT



2000ml x 4ea

NB-101M
NB-101MT



2 Stairs

NB-101M
NB-101MT



Holders

NB-101M
NB-101MT